

HSO321S RTC SERIES

CRYSTAL OSCILLATOR, SPXO

☑ RoHS Compliant ☑ Pb Free

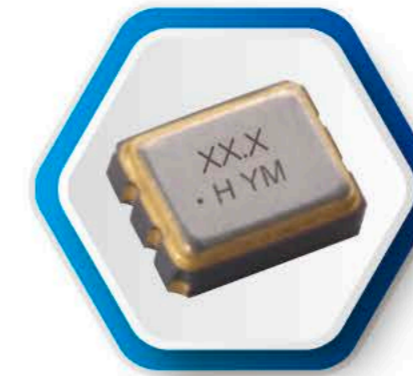

DIMENSION

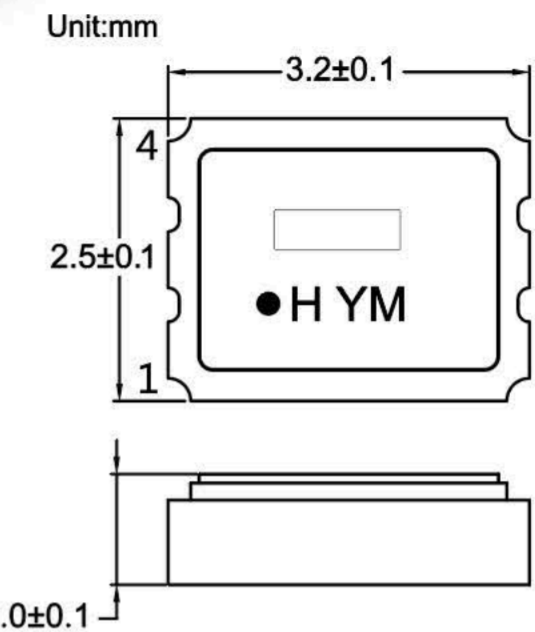

Recommended Land Pattern
Tolerance: ±0.1

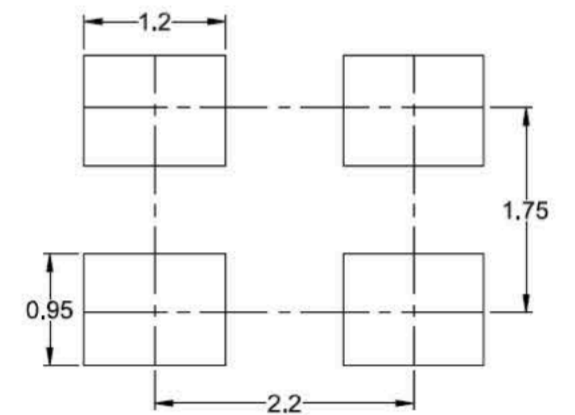

Bottom View

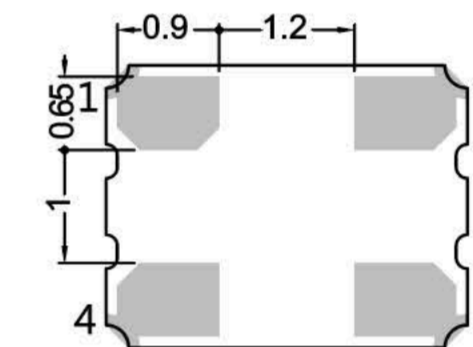

Pin Connections	
#1	OE(Output Enable)
#2	GND
#3	Output
#4	Vdd

STANDARD SPECIFICATION

Items		Parameter			
Frequency Range		32.768kHz			
Power Voltage (±10%)		+1.8 V	+2.5 V	+2.8 V	+3.3 V
Output Character	"0" Level	10%VDD Max.			
	"1" Level	90%VDD Min.			
	Rise Time (Tr)	10% ~ 90%VDD 300ns Max.			
	Fall Time (Tf)	90% ~ 10%VDD 300ns Max.			
	Symmetry	60/40 to 40/60 at 50%VDD			
Output Load		15pF Max.			
Current Consumption	I _{cc}	2 mA Max.			
Stand-by Current (#1 pin = "L" Level)	I _{std}	10 uA Max.			
Start-up Time		10 ms Max.			
Storage Temp.		-55°C ~ +125°C			

FREQUENCY STABILITY OVER OPERATING TEMPERATURE RANGE

Operating Temperature	Stability
-10 ~ +70°C	±20ppm
-40 ~ +85°C	±25ppm
-40 ~ +125°C	±100 ppm

TEST CIRCUIT AND OUTPUT WAVEFORM

Measurement Circuit

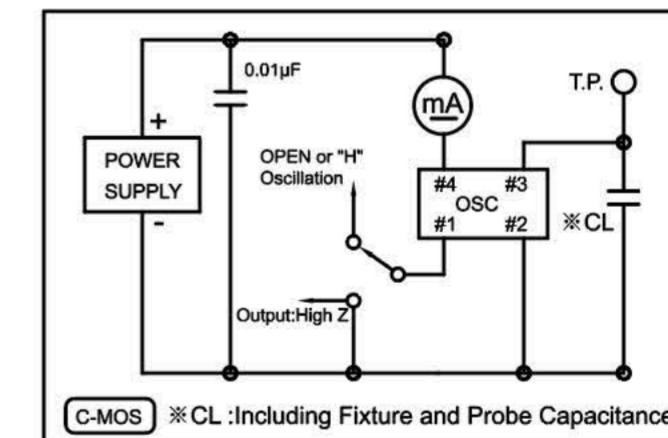

Output Waveform

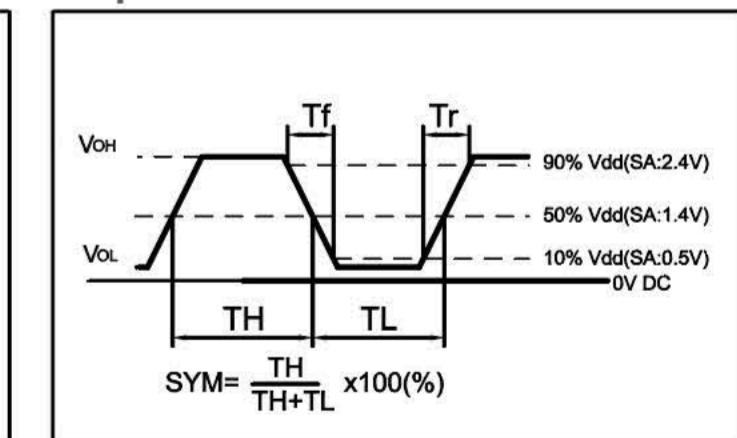

Input and Output Condition

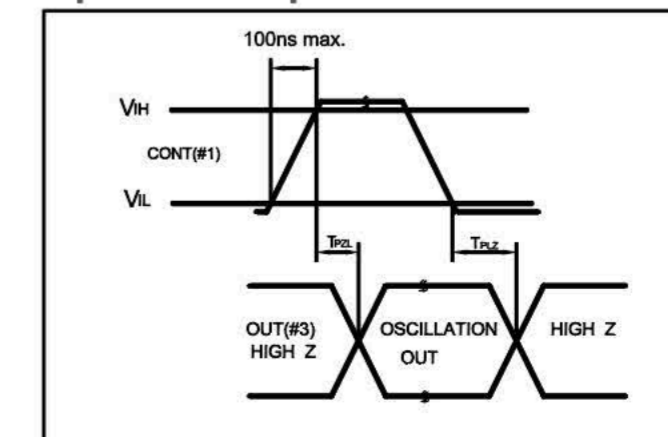

*For other specification, please contact us.

Packing Unit : 3,000pcs/Reel.

Actual Size